

STANDARD HIRE JACKLEG UNITS

12ft x 9ft
Open Plan

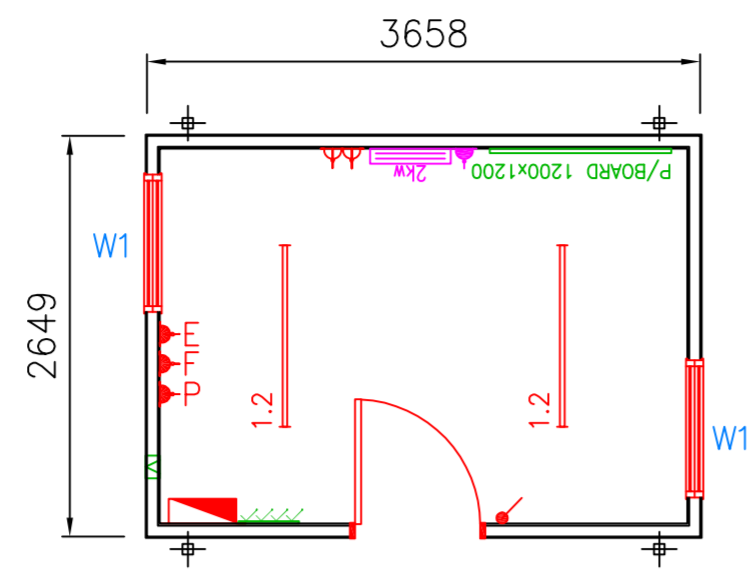

16ft x 9ft
Open Plan

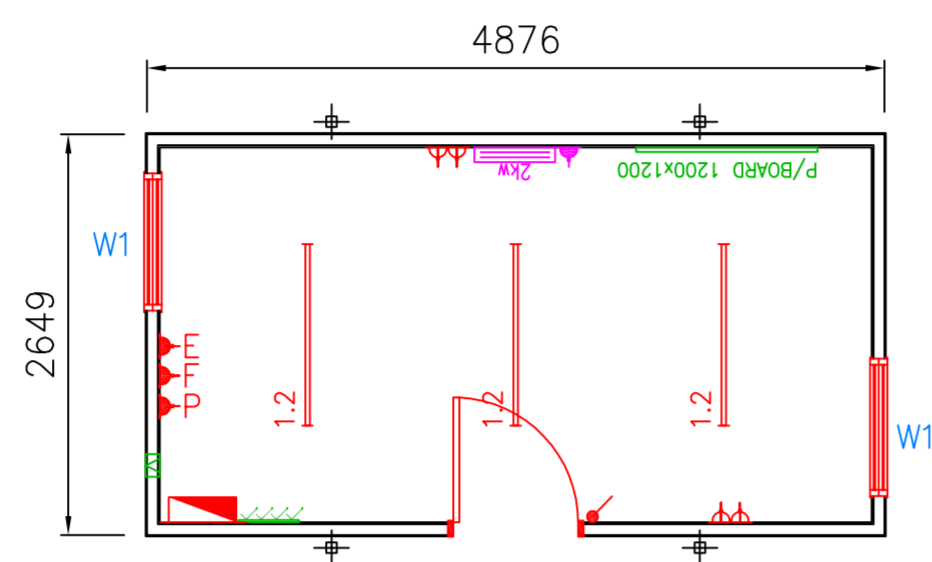

24ft x 9ft
Open Plan

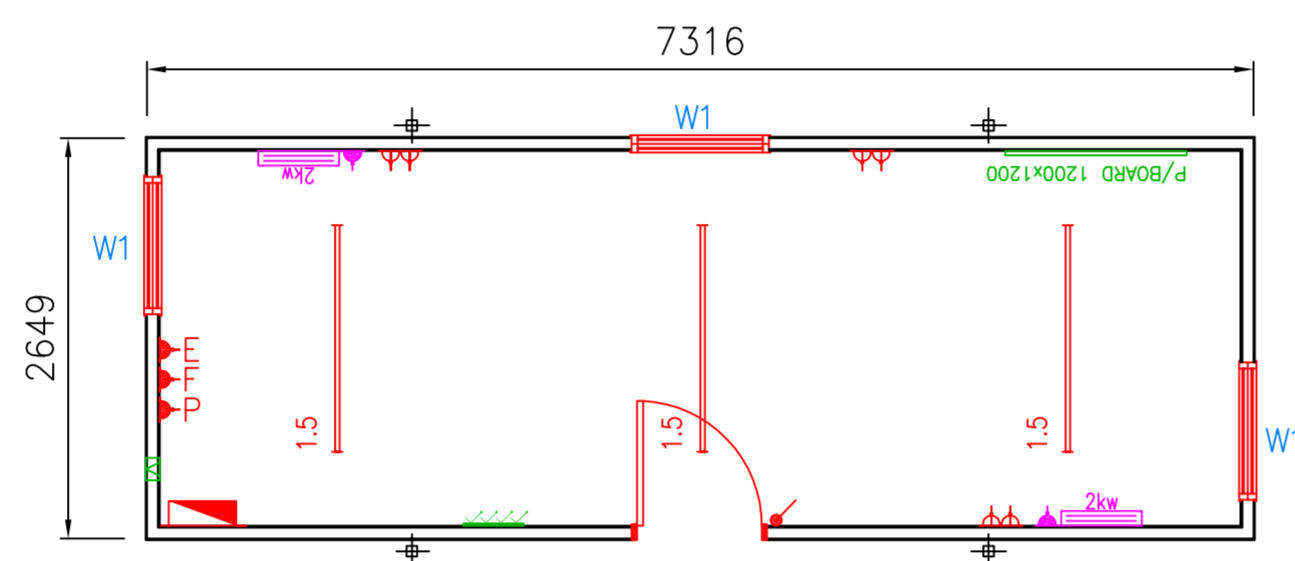

32ft x 10ft
Twin Office

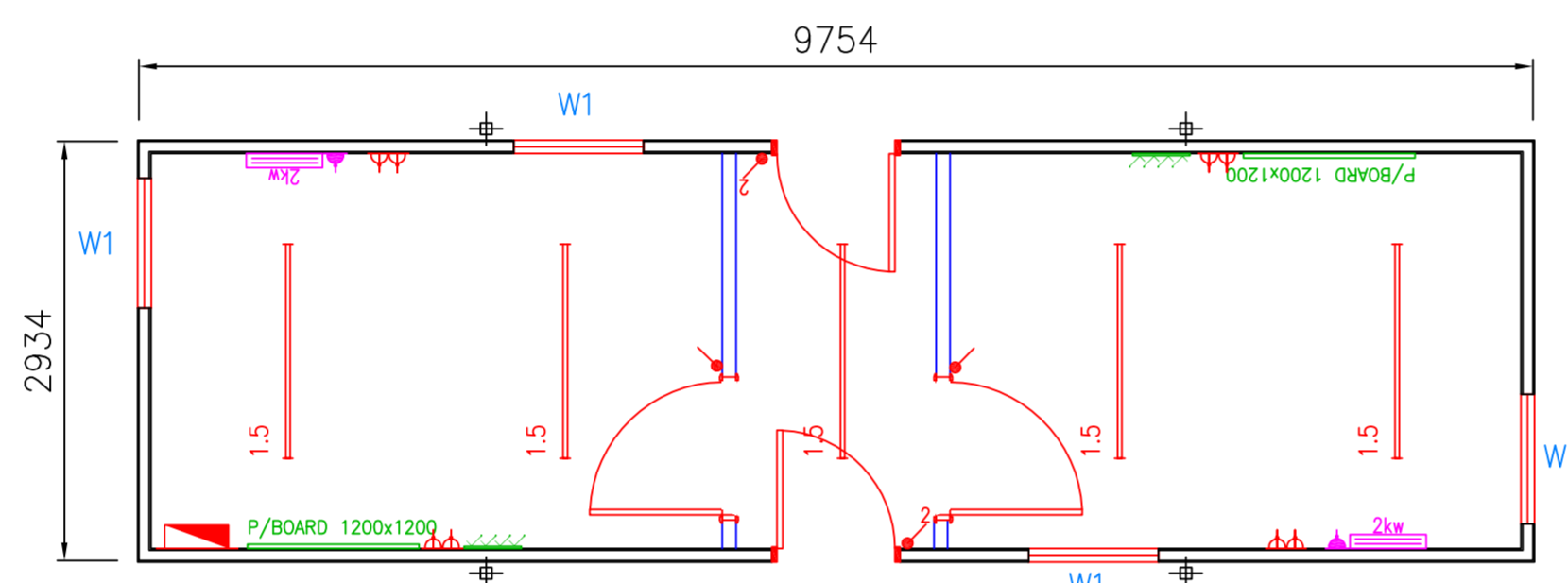

32ft x 10ft
Drying Room
& Kitchen

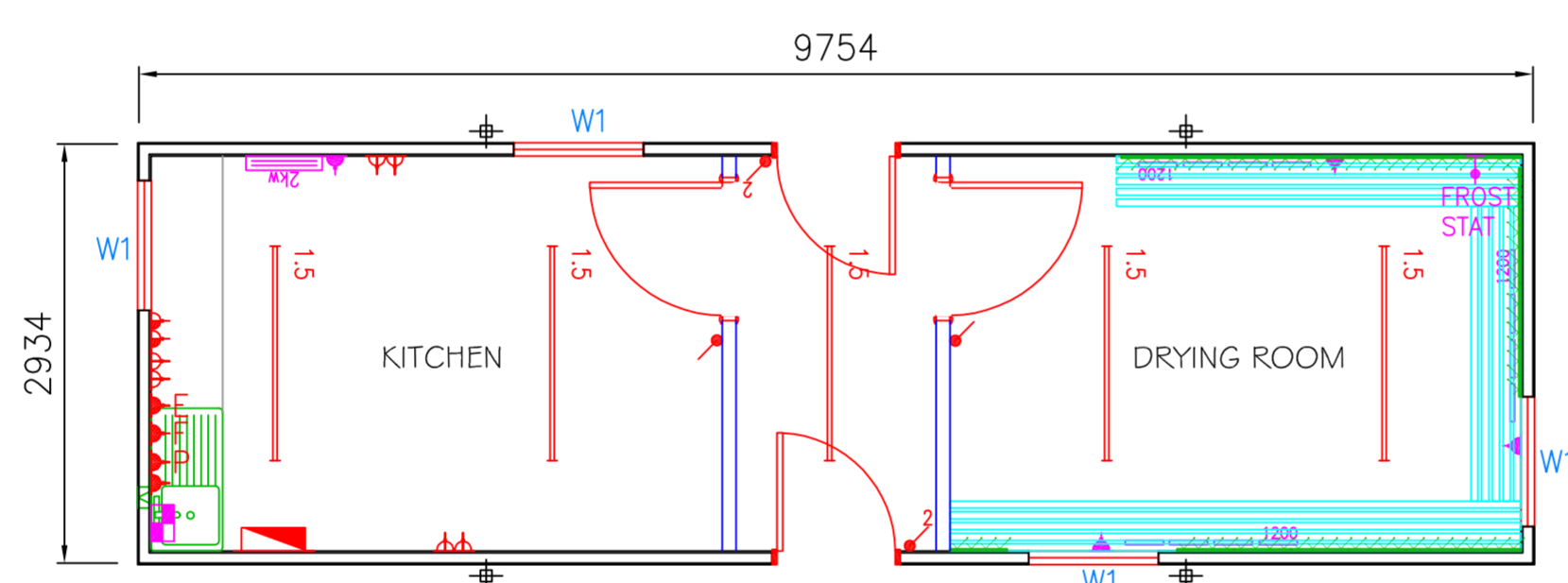

32ft x 10ft
Drying Room

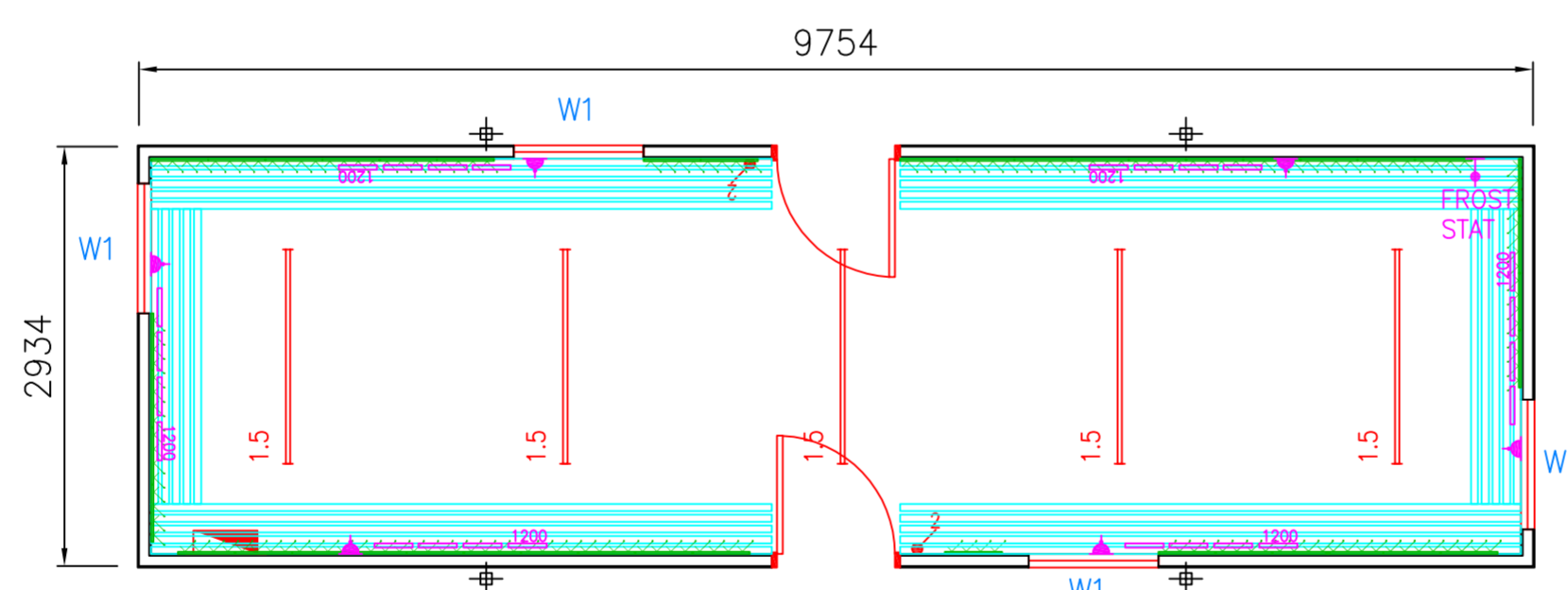



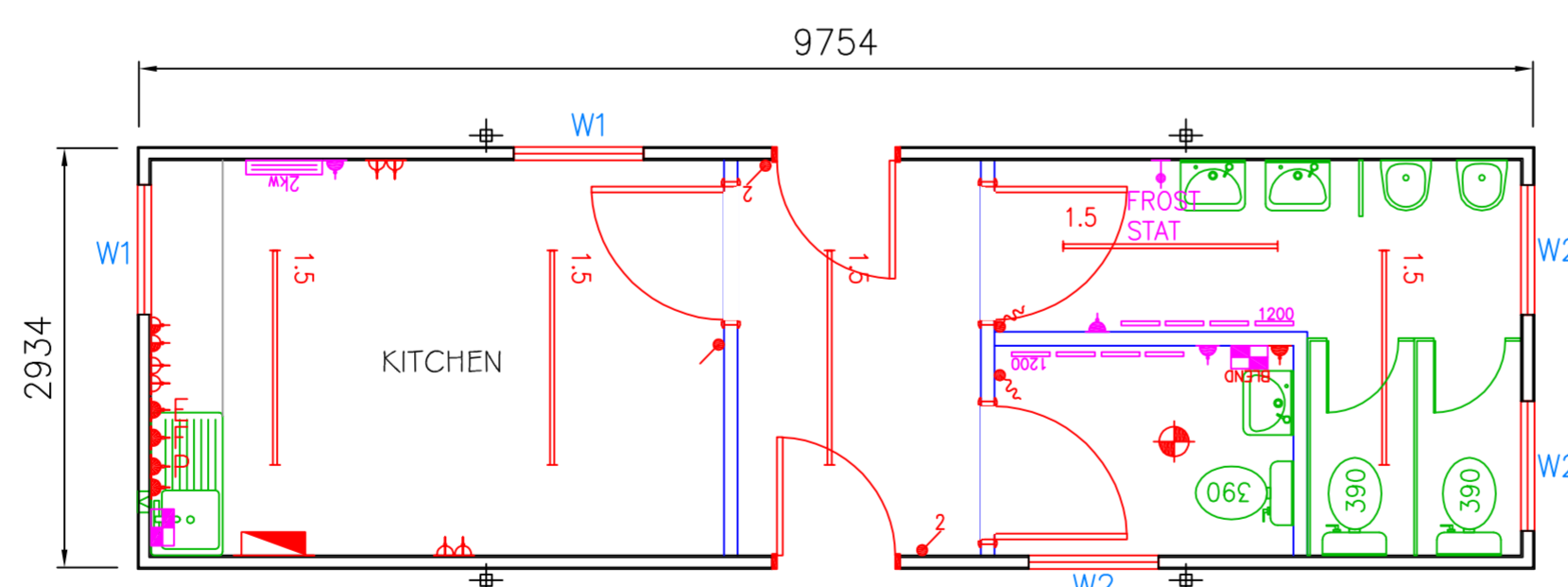



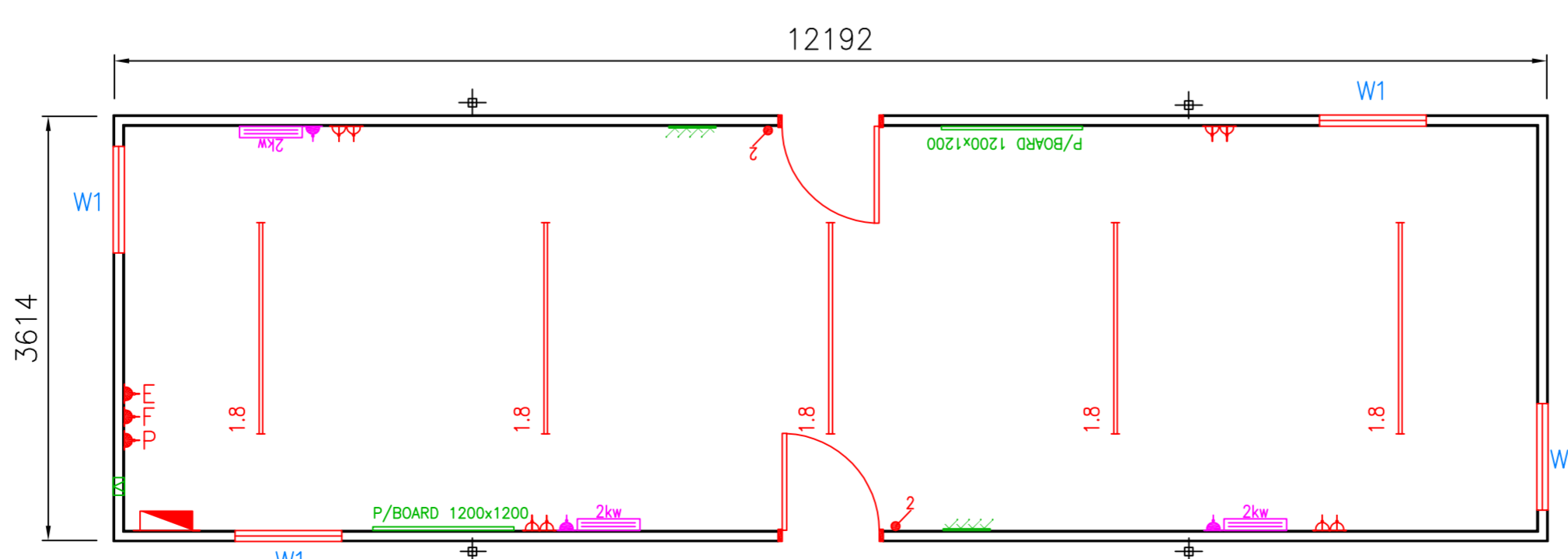







32ft x 10ft
Kitchen &
Toilet



40ft x 12ft
Open Plan



-  MAINSBOARD
-  13A DOUBLE SOCKET (450mm AFFL)
-  13A HIGH LEVEL DOUBLE SOCKET (1100mm AFFL)
-  20A DOUBLE POLE LIGHTSWITCH
-  1.2 1200mm SINGLE FLUORESCENT LIGHT
-  1.5 1500mm SINGLE FLUORESCENT LIGHT
-  10A TWO WAY LIGHTSWITCH
-  1.8 1800mm SINGLE FLUORESCENT LIGHT
-  2D 28W INTERNAL LIGHT
-  6A DOUBLE POLE PULLSWITCH
-  2kWh CONVECTOR HEATER
-  1200mm TUBULAR HEATER
-  FROST THERMOSTAT
-  UNDER SINK WATER HEATER
-  WATER HEATER WITH BLENDER